



Beginners guide to Solar

For more information visit | www.lgenergy.com.au





TABLE OF CONTENTS

Why You Should Choose a Solar System	3
The Benefits of Going Solar	4
How a Grid System Works	5
The Components of your Solar System	6
Solar Panels	6
Inverter Solutions	6
Batteries	7
Mounting Systems	7
Metering your Solar System	7
Your Solar System Size	8
Measuring how your components perform. The Difference between kW and kW/h	8
Installing PV Panels for your Solar System	9
Tilting and Orientation	9
Daily Routine	9
Shading	9
Mounting	10
Installing Panels for Great Performance	10
How Long Solar Systems Last	11
Solar Panel Sizes	12
Incentives, Rebates and Financing	13
Are There Rebates Available for Your Solar System?	13
What are STC Certificates?	13
What are Feed in Tariffs?	13
Payment Plans	13
Details on How to Choose a Solar Installer	14
Questions to Ask Before you Buy	15
Additional Tips to Avoid Poor Quality Solar Equipment	16

WHY SHOULD YOU CHOOSE SOLAR?

Over the past five years, the cost of installing a solar system has reduced. Solar energy used during the day, and soon with batteries supplying electricity at night can generate significant savings by reducing your electricity bill.

Consumers of electricity who do not have solar systems are going to pay for their electricity indefinitely. In regards to electricity consumption, users are like a tenant who will keep on paying indefinitely for the accommodation.

By owning a solar system you typically own a big share of the electricity you consume, with the savings you make immediately starting to pay off the cost of your investment. For many homes in about five to six years, your power savings will have paid off the investment you spent.

With a top LG solar system you will join the hundreds of thousands of home owners across Australia and the world who have already chosen LG solar panels and you and your family will continue to save on electricity bills for years to come.



To help you select and install your solar system, a certified LG installer will guide you through the process from the moment you first consider solar panels to the planning and installation phases of your home or business solar system. You can find an installer who will supply a free detailed quote via the dealer search at lgenergy.com.au

THE BENEFITS OF GOING SOLAR

So, what are the benefits of a residential solar system?

1. Solar Power can save you money – Installing Solar power enables you to generate your own electricity. By using your own electricity rather than buying it from your electricity company, you will save money as every kW/h of electricity you use from your solar system is a kW/h of electricity you do not have to buy from your electricity company.

2. Environmental Benefits – By using electricity generated from solar panels, we reduce the need to generate electricity from fossil fuels like coal and gas which create carbon dioxide (CO₂). This can reduce the potential for global warming and can create a more sustainable cleaner energy mix, this effect is even stronger if your solar system lasts a long time.

3. Energy Independence – By owning your own solar system, you have the capacity to create your own electricity. This reduces your reliance on the electricity grid and electricity retailers etc and increases your control over your future electricity needs, expenses and lifestyle especially if you add batteries to your system in the future.

4. Property Value – there are studies that show that installing a quality residential solar system may increase the value of your home. Home buyers are increasingly recognising that a home with quality solar panels installed will have lower electricity costs. <http://www.realestate.com.au/news/85-of-aussies-say-solar-panels-boost-property-prices/>

5. Energy reliability – High quality solar power systems are a reliable power source. The sun rises and sets every day, while the sun shines, solar panels will generate electricity. While the weather and the seasons vary, the amount of electricity that the panels generate is predictable. You can also increase the financial benefits of your solar system by changing the times you operate your household appliances. For example, turning your washing machine on as you leave home in the morning and avoiding washing your clothes at night allows your solar system to power your washing machine during the day. With the help of lithium-ion batteries, which are becoming more affordable, you can also store solar power during the day and use it at night.



To assess your energy usage profile and discover the benefits that you may derive from a solar system, talk to one of the LG Authorised Dealers from an LG Dealer Search on lgenergy.com.au

HOW A GRID SYSTEM WORKS

A solar system is made up of multiple solar photovoltaic (PV) panels, a DC to AC power converter (inverter solution) and a framing system to hold the PV panels in place.

PV panels are generally fitted on the roof facing an northerly, easterly or westerly direction, and tilted at a particular angle to maximise the amount of sunlight that each panel receives.

Suburban homes in Australia and New Zealand are connected to the electricity grid via power lines. Our electricity system uses 240V alternating current (AC), but the electricity generated by solar panels consists of variable direct current (DC). To transform the DC electricity into AC electricity for ordinary household use, grid-connected solar PV systems have inverters attached to each PV panel called micro inverters or a single inverter for a string of connected PV panels called a central string inverter.

The third possible inverter solutions are power optimisers, which are a variance of the string inverter and the micro inverter. All these technical solutions can create a great solar system.

Ask your authorised LG Energy Partner for advice on which of these inverter solutions offer the most suitable solution for you. Quality inverter/micro inverter solutions include Fronius, SMA, Solaredge and Enphase brands.

Today houses with grid-connected solar systems consume solar-generated electricity first, before switching to the electricity grid if more electricity is required than the solar system is able to generate.

Grid-connected solar systems can also feed electricity back to the grid if too much electricity is generated via the solar system for the immediate needs of your home. For information on rebates and rewards associated to feed-back electricity see page 13.

Unless you add storage batteries to your system, a grid-connected solar system is unable to store power in your home for use at night.

GRID CONNECTED HOME WITHOUT BATTERIES

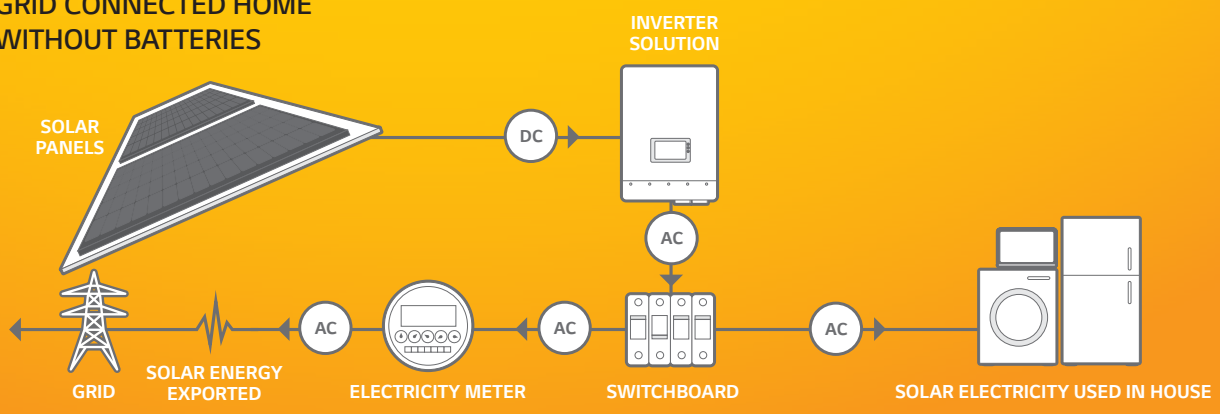

GRID CONNECTED HOME WITH BATTERIES

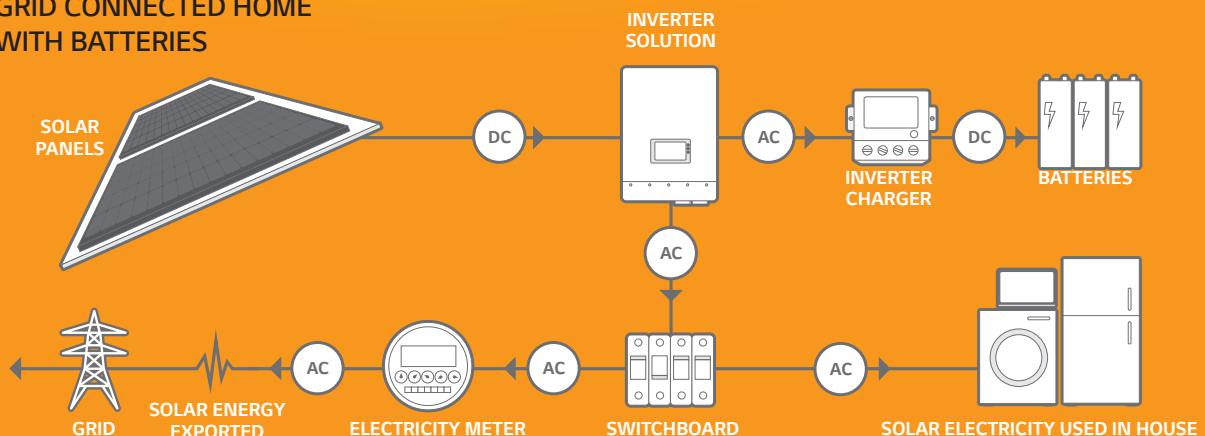

THE COMPONENTS OF YOUR SOLAR SYSTEM

What makes up a solar system?

A solar system is made up of a number of key components, all of which combine to generate electricity, regulate and control the flow of the electricity and to connect and mount the solar system to your building. A grid-connected solar system comprises of panels, a string inverter or micro-inverters or optimisers, a roof mounting system and electrical accessories including circuit breakers and wires. It is important that all components work together, with no component compromising the performance, safety or life expectancy of any other component.

SOLAR PANELS

Solar PV panels on roofs of homes and businesses generate clean electricity by converting sunlight into usable electricity. This conversion takes place within the solar cells and is a process that requires no moving parts.



325 to 335W
LG NeON²



350 to 365W
LG NeON^R



SOLAR EDGE INVERTER



ENPHASE MICRO INVERTER

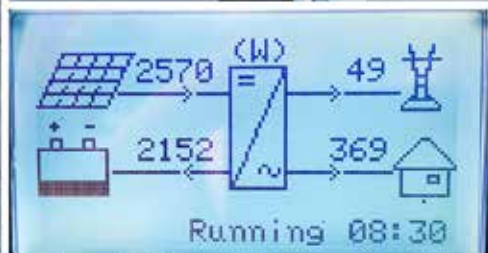

INVERTER SOLUTIONS

A solar inverter is one of the most important elements of the solar system. It converts the variable direct current (DC) output of a photovoltaic (PV) solar panel into a 240V alternating current (AC). This AC electricity can be fed into your home to operate your household appliances.

Depending on how your system is set-up the electricity that is not used in your home is either fed into the grid via a digital meter or stored in home batteries for later use. New hybrid inverters now include an integrated battery management system.

Long lasting solar systems for the Australian climate require high quality inverters. Unfortunately, lower quality inverters and panels have failed to perform under Australian conditions in large numbers and failed in as little as 2 years.



SMA INVERTER

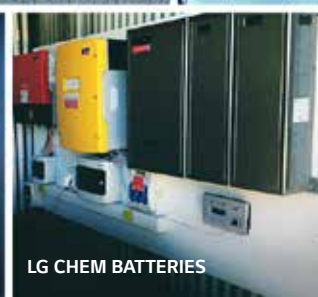

LG CHEM BATTERIES



FRONIUS INVERTERS

BATTERIES

Since 2015 solar storage batteries have reduced steadily in cost to the point that pay back for many households is coming down from more than 10 years towards 7 years and less. At LG we believe that in future years most residential solar systems will include a battery as part of the solar system package. Discuss with your LG Energy Partner if batteries are feasible in your circumstances, or if you should get a “battery ready” system.

MOUNTING SYSTEMS

Solar systems are mounted to roofs with a mounting system using various railings, frames and tiles or tin feet. Most mounting systems are made of aluminium with stainless steel hardware and are designed to accept a variety of solar modules on a variety of roof types. Aluminium rails with clamps attach the solar panels to the rail and connection brackets fix the rail to the roof (see diagram below).

Superior mounting systems are manufactured with higher grades of aluminium and stainless steel, often resulting in less weight on the roof and lower levels of corrosion over longer periods of time. Quality mounting rails may also feature robust anchoring points and design solutions that speed-up the installation time of your solar system.

Purchasing a strong and well-engineered mounting system is the sensible way to protect the investment you have made in your solar system as they will be more rigid. The standard mounting frame warranty is 10 years.

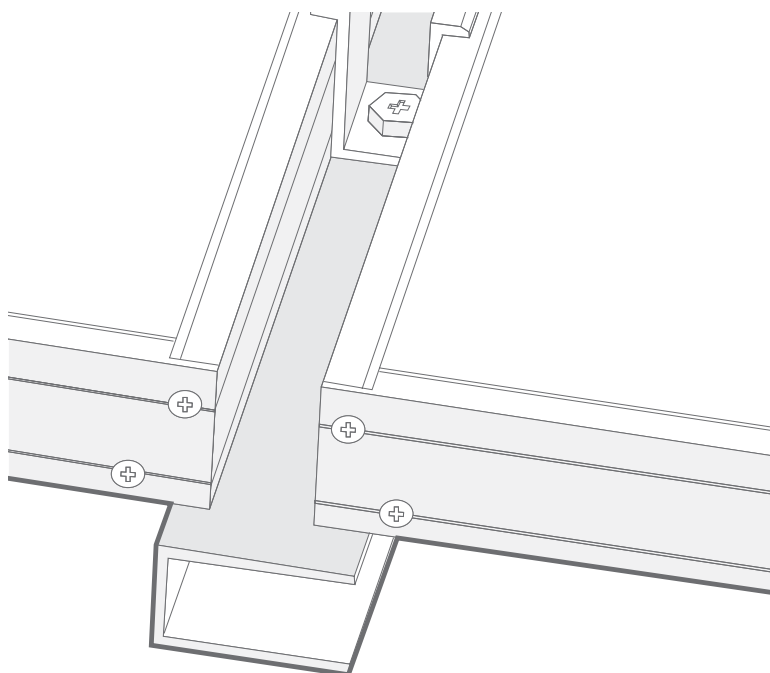

CLIP MOUNTING



METERING YOUR SOLAR SYSTEM

There are two fundamental steps to take when connecting your solar system to the grid

Step 1. Your electricity network company will specify what type of meter is required to measure your solar generation and energy consumption. Your LG Energy Partner will be able to explain the details to you. You may be required to pay for the cost of the new solar meter and its installation in addition to the cost of your solar system. Prices can be a few hundred dollars, so you should make sure that the solar electricity meter supply and connection is included in the quote for your new solar system.

Step 2. Shop around for a competitive rate for off-set and exported electricity from your solar system with your electricity retailer. This is called a ‘feed-in tariff’ (FIT) and varies by retailer and location. Some electricity retailers may offer a low FIT. If your existing electricity retailer does not offer an attractive solar FIT, you may wish to consider changing your retailer to a retailer who does. Your solar system installer will be able to advise you on who offers the best FIT in your area and assist you with the process.

We recommend you only use quality panels/ inverter solutions for long lasting systems

YOUR SOLAR SYSTEM SIZE

Your LG solar system is rated according to the number of Watts it can produce per hour. This rating is rarely achieved in full during real life conditions as dust particles, clouds and other natural issues will affect the quality of light that your PV panels receive.

For example 16 x 330W solar panels will create a 5,280 kW solar system. In regards to overall system output on an average day with intermittent clouds this system will produce approximately 3-4 kW per hour in the best sun irradiation hours of the day. The system will only achieve 5kW per hour on a very sunny day, in the middle of the day and clear sky, for example after rain.



*In 2016 LG panels won the prestigious Intersolar Award and in 2016, 2017 and 2018 the prestigious Top Brand Award.

LG Panels look fantastic on your roof.
A smart looking home is a more valuable asset.
Invest in LG panels for better long term outcomes.

LG PANELS

CONVENTIONAL PANELS



MEASURING HOW YOUR COMPONENTS PERFORM. THE DIFFERENCE BETWEEN KW AND kWh

kW stands for kilowatt or 1,000 Watts and is a measure of power

kWh stands for kilowatts per hour and is a measure of energy

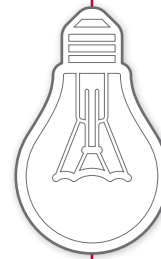

25kWh – The average residential household's daily consumption

Electricity bills are usually measured in units of kWh. Solar Panels are measured in Watts. E.g. LG Neon 330W

A 1 kW electric pool pump used for one hour will consume 1 kWh of electricity

Twenty x 50W down lights used for an hour will consume 1 kWh of electricity (20 x 50 = 1,000)



INSTALLING PV PANELS FOR YOUR SOLAR SYSTEM

TILTING AND ORIENTATION

Solar modules can face anywhere from the East to the North and the West, while still providing good output performance.

In Australia, a grid-connected solar system will generate the most solar electricity when the LG solar panels are facing north at a tilt angle of 15 to 30 degrees. But with the introduction of time of use metering by electricity providers in Australia, a north-west or fully western facing solar system may give a more positive financial outcome.

Time of use metering is when energy retailers charge more for their electricity (approximately 45 cents per kW/h or more) in peak usage periods, for example weekdays from 2pm until 8pm. During these times Western facing panels will produce a greater amount of solar electricity, therefore creating better savings.

Discuss with your LG Authorised Partner your electricity usage, so that your usage pattern can be matched with your solar panels installation direction. Of course the setup of your roof also plays a major role where the panels can be installed.

DAILY ROUTINE

Thinking about your daily routine and your electricity consumption will help you locate the best possible position for your solar panels. If lots of electricity is used in the morning, an easterly roof will offer the best benefits. If lots of electricity is used during the middle of the day, we would advise a north facing roof and if lots of electricity is used in the early and late afternoon a north-west facing roof is more likely to offer the best outcome. With multi-string inverters you can also put one group of solar panels (one string) on the east and one on the west to cover a wider time-span.



SHADING

The amount of electricity generated by your solar system directly relates to the amount of sunlight that your PV panels receive. The more your solar modules are covered in shade, the less electricity your system will generate.

Even a single antenna or a chimney shadow on your panels can affect performance, while the overall effectiveness of your solar system is dependent on where you live. In some areas of Australia (for example, the Blue Mountains near Sydney) over 20% of homes have reduced suitability for solar systems due to extended tree coverage close to the home.

Using micro-inverters or power optimisers on each panel, instead of one large string inverter (where multiple panels are connected to one inverter) can help with shadow issues. With each individual panel managed to achieve its maximum electricity output individually, the losses associated to shade can be reduced by as much as 25%.

If you believe that you may have a shadow issue, talk to your LG Energy Partner and check if power optimisers or micro-inverters are a potential solution for you.

MOUNTING

If a suitable roof area is not available at your home, LG solar panels can be fitted to a ground-mounted system in a sun-filled spot on your land.

However, you will need to allow for additional costs for a ground mounting system, including costs for running the cable safely in the ground. These options can be discussed with your local LG solar dealer.



INSTALLING PANELS FOR GREAT PERFORMANCE

LG is confident that our panels will give you years of reliable functionality. As of March 2018 only 10 panels have needed to be replaced from over 550,000 panels installed across Australia since 2011. Although the cables, safety devices and mounting systems are less influential to the performance of your solar system, the use of poor quality cables or isolators can lead to premature system failures. In cases where non-branded plugs and cables were used, complete system failures have occurred.

For a decade of low maintenance to your solar system, it is strongly suggested that you purchase high

quality solar panels, quality solar inverters and ask for a quality balance of system components in all aspects of your solar system.

Some cheap solar panels have failed in the Australian and NZ climate in as little as 24 months. Typical issues have been water ingress, corrosion, hot-spots, failed bypass diodes or junction box failures. These type of failures lead to the write off of the panel. Often the lengthy promised warranties are hard to claim when dealers, installers or panel manufacturers have gone into liquidation or have stopped operating in Australia/NZ.

Electricity bills are usually measured in units of kWh. Solar Panels are measured in Watts. E.g. LG Neon 320W

Over 560 solar installation companies have gone into liquidation since 2011*. If you select a LG Authorised Energy Partner you have an installation company that has gone through detailed vetting by LG.

HOW MANY PANELS DOES YOUR SOLAR SYSTEM NEED?

An LG Authorised Energy Partner will visit your home for a site inspection, checking the roof position, discussing your electricity usage pattern, discussing monitor options and, where applicable, conducting a shade analysis to ensure that the right quantity of the most suitable panels are placed in the optimum position.

Buyers should insist that their installation company also undertake a physical site inspection. Many variables require consideration, with many difficult to spot from satellite images or from aerial photos of your home. An installer's willingness to visit your home gives some indication as to the quality of service you will receive for your purchase. As a result, we advise that you buy your solar system from a local company and not an internet-based solar sales agent.

Historically (when internet solar sales were rapidly increasing) consumers purchased solar systems without site inspections. Sometimes this resulted in their installer highlighting the need for special roof brackets or a total switchboard upgrade before the solar system could be installed. These additions added unexpected costs and time delays to the installation.

Before making your purchase decision, check who your point of contact is if you have questions after your installation. Make sure that you ask for a comprehensive written warranty from the installation company for the cabling and installation work, not just the panels, inverter and mounting frame.



HOW LONG SOLAR SYSTEMS LAST

The key components susceptible to failure in your solar system are the solar panels, the inverter and some components like fuses and isolators.

High quality solar products overall tend to have longer life-cycles as they undertake more quality control steps, use higher quality cells and solders, have stronger UV protection on backing sheets and ensure the water sealing of panels withstands decades of weather induced deterioration. Very low cost panels with less UV stabilised backing sheets, cheaper sealants and more fragile framing can deteriorate faster and many have failed in Australia in as little as 2-4 years.

Cheap inverter solutions also have higher failure rates than quality solutions. Unfortunately sometimes lengthy warranties on cheap products have been unobtainable as both manufacturers and installation company have avoided liability by going into liquidation (e.g. Sunnyroo or Aearosharp inverters). In Australia over 560 installation companies have liquidated their business and likely escaped warranty obligations since early 2011*.

The key warranty for solar panels is the Manufacturer's Warranty. High quality panels cover transport of the replacement panel, the replacement panel and the labour to take the failed panel down and replace it. Cheaper panels often do not cover transport and replacement labour. Make sure you enquire what is covered in the warranty and ask for the detailed warranty document. Standard Manufacturers Warranties are usually for 10 years. By comparison, LG NeON 2 and LG NeON R panels have a 25 year warranty.

SOLAR PANEL SIZES



FOODBANK, WESTERN SYDNEY, 250KW LG NeON® 2 SYSTEM

SOLAR SYSTEM SIZE GUIDE

SMALL HOME

 1-2 People
2-3kW System
 Av. production per day: 12 kWh

MEDIUM HOME

 2-3 People
3-4kW System
 Av. production per day: 16 kWh

LARGE HOME

 4+ People
5-8kW System
 Av. production per day: 36 kWh

*This is a general guide only and does not take your specific energy use requirements and practices into consideration. Please contact your LG Energy Partner for more detailed guidance on your solar system size.

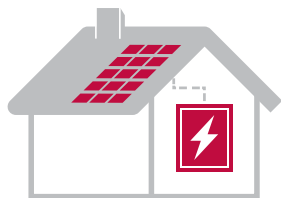

Capacity of solar power system with 20 panels (60 Cells per panel)

7.3
kWp

365W NeON R Panel

6.7
kWp

335W NeON 2 Panel

5.4
kWp

270W Poly Standard Panel

WHY PANEL EFFICIENCY MATTERS

A few years ago many buyers of residential solar did not consider the efficiency of their panels. If they wanted a 5kW system they could buy 20 panels with 250W or 23 less efficient 220W panels. Most customers never imagined they would in the future need more than 5kW of solar and in many homes around 20 to 32 panels will fit on the roof. That was the old solar thinking.

With the emergence of battery storage as a smart way to harvest the light during the day and then to use this electricity at night, panel efficiency has become a very important consideration. Considering that the future of electric cars is coming fast, with Volkswagen for example announcing many electric car models in the near future; you might want to expand your solar system in the future to power your electric car.

Worldwide CO₂ emission reduction could be enormous if we are able to utilise our roofs to generate more of the fuel for our cars. In short in the future one might want a 5kW solar system for day use and 2kW

of solar for the batteries to use at night. Charging the car would require another 4-8kW of solar to power the car(s). Overall suddenly there is the need for a 10 -15kW system. With 270W panels this would mean one needs to fit at least 40 panels. On the other hand, with the highly efficient 365W LG panels one would need only 29 panels.

LG have now released a 360W and 365W NeON R in the 60 cell range and a 405W panel in the 72 cell range. This means if you can save 8 spots now, with a higher efficient panel – you can have another 3.6kW solar system for your batteries or cars, which you would not be able to fit otherwise.

So it is important today to buy a system with future expansion capability in mind, both for batteries and future electric vehicles.

Buy now with the needs of the future in mind. Choose high efficient panels and keep spare roof space for future expansion.

INCENTIVES, REBATES AND FINANCING

ARE THERE REBATES AVAILABLE FOR YOUR SOLAR SYSTEM?

Rebates may be available for your solar system. Over the years these rebates have changed and may continue to change in the future. Talking to your nearest LG Energy Partner will give you updated information about the latest rebates applicable to you.

There is currently one key rebate offered for solar PV systems in Australia called Small Scale Technology Certificates (STCs). As per April 2018, this rebate offered around \$3200 towards a 5kW system, but the rebate amount can change from time to time. When you see advertised sales prices for solar systems, these prices usually have subtracted the rebate from the full price. The rebate will reduce every year in January, for the next few years.

WHAT ARE FEED IN TARIFFS?

Feed-in tariffs (FIT) are a defined payment for the electricity you generate from your solar system that is sent back to the grid. Currently energy retailers in most States pay FIT ranging from 9-12 cents. These FIT rates are based on state guidelines and vary between electricity retailers. We recommend shopping around between retailers to determine the best available FIT rate for you.

Some Energy Retailers sell solar systems and will tempt you with a high FIT. Please check that the overall electricity charges in such contracts are not higher than normal kWh charges, as your higher FIT income may be more than offset in higher electricity fees and charges.

Previously around 2010, Australian solar system owners have benefited from a range of generous "premium" FIT schemes. Unfortunately, these offers are no longer available with new solar installations.

The value of a FIT is an important aspect to consider as it can influence the economic outcome of owning a solar system and what the ideal size of a system should be in your individual case. Good solar installation companies as part of their site visit should offer a detailed analysis of what they expect your self-consumption to export ratio to be, and what economic outcome you will be able to achieve.

Naturally if you install batteries with your solar system the FIT is less relevant.

PAYMENT PLANS

Consumers also have the option to finance a solar system. Often homeowners redraw on their mortgage to finance the solar and battery system. Your installer can advise you about other available finance options.



LG PANELS ARE ALSO USED IN MANY COMMERCIAL INSTALLATIONS IN AUSTRALIA.



DETAILS ON HOW TO CHOOSE A SOLAR COMPANY

It is recommended to use a reputable installation company that checks your specific solar system requirements. Please see the points below regarding the advantages of using a company promoting high quality products.

- ① A reputable solar retail company is more likely to fully evaluate your requirements and explain in detail what needs to be done in order to install your solar system.
- ② A local diversified company is more likely to be around in the future to service any warranty issues or system upgrades. With some loud, marketing and price focused solar companies longevity of the company can be an issue.
- ③ If your installer is selling you LG solar panels, then in future years LG is very likely to be able to have a local company service your LG panels. If you choose an unknown brand, the manufacturer may go out of business or the importer may stop importing these panels into Australia. It is recommended to buy branded solar panels from diversified manufacturers like LG that have a sound track record in Australia.
- ④ A reputable solar company will be fully aware of current electricity supply rules as well as provide you advice on the best feed-in-tariff. As a result, well established businesses will be more likely to give you the most up-to date advice.
- ⑤ If your local installer belongs to the Authorised LG Energy Partner network, then he/she has to install the solar power system to a high standard and act ethically in their business dealings with you, the customer.

All systems installed in Australia have to be signed off by an accredited solar system designer/installer. The following elements are considered when designing a solar system:

- a. Your current electricity consumption and future needs;
- b. The available roof space and optimum panel location;
- c. The orientation and pitch of the roof(s);
- d. Impact of shading across all seasons and time of day;
- e. The structural soundness of the roof;
- f. Sizing the strings of panels for the correct voltage of the inverter solution;
- g. Ensuring the design meets building codes and electrical standards;
- h. Determining the most suitable location for the inverter and the way the cables are run;
- i. Considering appropriate monitor options and considering if batteries are appropriate.

*Source: ASIC liquidated companies register

QUESTIONS TO ASK BEFORE YOU BUY

Asking your solar installer a few essential questions may make a big difference to the service and benefits you receive. Make sure you get the answers in writing.

- 1 What is the estimated monthly and annual production in kWh of my system in its installation position?
- 2 What is the estimated solar electricity production in the best and worst months? Also please check out the LG output calculator on www.lgenergy.com.au
- 3 Who will service and maintain my solar system? Get an address and contact details in writing, preferably of someone reasonably local.
- 4 Get clarity as to what are the responsibilities of each party? Including the installer, manufacturer and consumer.
- 5 Who is responsible for connecting your solar PV system to the electricity grid? Is it the installer or another subcontractor? When will it happen?
- 6 Who is responsible for your meter change? Make sure this is clarified. Quality installation companies usually offer to accommodate the whole job.
- 7 Ask how the installer will credit your solar rebate (STCs)?
- 8 Get a detailed hand over manual.

IMPORTANT

WHAT YOU SHOULD KNOW ABOUT THE 25 YEAR OUTPUT "WARRANTY"

Over time solar panels will show degradation and produce each year a little less electricity. In order to give purchasers some guidance about the level of degradation, an Output Warranty is offered by most manufacturers. This Output Warranty goes in most cases for 25 years and guarantees that for conventional panels an output of around 80% of initial production efficiency is still maintained by the panel (LG NeON 2 offers 86%).

Unfortunately, this "Warranty" can easily cause confusion. Please note an Output Warranty IS NOT a Manufacturer's Warranty on the actual panel. For example, if in year 13 your panel fails completely, then the Output Warranty may not cover the faulty panel. A panel has to be in working order to claim an Output Warranty.

In many sales promotions the 25 YEAR Warranty is highlighted but when you read the details of an Output Warranty, you will have to pay for getting panels off the roof, shipped for testing and then also pay for the return and reinstall.

Often the compensation for a poor performing panel is less than \$100, when the customer had to spend many hundreds of dollars on install/uninstall and on the process to show the output of the panel is poor. Therefore this warranty only has a low value. Be aware of glossy 25 Year Warranty stickers – it is the 10, 12 or 25 year (LG is 25 years) Manufacturer's Warranty not the Output Warranty that counts.



It is also important to get in writing the various component warranties including installer workmanship guarantee, schedule of when deposits and progress payments are due.

ADDITIONAL TIPS TO AVOID POOR QUALITY SOLAR EQUIPMENT

Unfortunately, as in any industry, some unscrupulous operators can affect the reputation of professional, positive and reliable suppliers. Please see the helpful hints below to give you a positive solar experience.

1. Undertake some solar research via our Frequently Asked Questions (FAQs) on lgenergy.com.au

2. Do your research about brands and prices. There are some very cheap offers in the market, but these cheaper deals can hide poor quality equipment that are made to appear like quality products. You are looking for a product that lasts 25 years so that your financial investment is repaid over and over. Find out about the company offering the very cheap deal. For internet research try Whirlpool – the Green Tech section: <http://forums.whirlpool.net.au/forum/143>.

3. Do not give into pressure selling and deadlines. It's one of the oldest sales tricks in the book. If the sales person cannot give you the time to make a considered decision, then what are they fearful you will discover about the deal if you spend some time doing a bit of research? If the company has just come into town for a solar deal, they will be gone after the install and you will be left to your own local devices. Please buy from reputable solar companies. In years to come you might need their solar expertise and support.

4. How big is your roof and how big a solar system can it fit? Try our roof size calculator to work out how big your solar system can be on your specific roof. To check the calculator results contact your local LG dealer. Remember to allow some reserve space for when you install a solar storage battery for night time solar power use, and then again for more battery storage capacity to charge up an electric car in future years. Your quality solar system is built to last 25+ years. Go back 25 years to the days of 'brick' mobile phones, dot matrix printers

and ghetto blasters to consider what the next 25 years may herald and how your home power needs may grow.

5. Solar systems vary in quality and size and so does the price. Set yourself a budget. As a rule of thumb each kW of a quality solar system will cost in the range of \$1,400 to \$1,700 for a residential system up to 10 kW. You will find a system for \$800 to \$1,000 per kW but you are looking at a much lower grade systems with less output productivity and shorter working life. This may cost you more in the future in repairs and replacements. Use your rebate wisely. You are making a 25 years or longer investment, so please consider quality and real warranty support over everything else. And remember a solar system with a good brand name and performance at the time you sell your home may increase your property value.

6. Panel Types & Certifications: We recommend the high efficiency NeON mono-crystalline solar panels, as this is the technology used most often in quality solar systems in the world today. It is also the most tested technology, as mono-crystalline panels have been mass produced since the 1970s. They have a black appearance and from our point of view will aesthetically blend in more to your roof and neighbourhood than the blue multi-crystalline solar panel variety.

7. Solar systems attract government rebates if they have been registered with the Clean Energy Council. You should check with the install companies if the offered panels are registered (most are nowadays). All LG panels are registered and have completed extensive fire resistance testing.

8. Manufacturer's Warranty: Many manufacturers will offer 10 years' manufacturing warranty and an 80.2% output efficiency warranty at 25 years (LG offers 86%). For a normal consumer it becomes difficult to separate the "wheat from the chaff". Companies like LG offer full parts and labour warranty and a replacement warranty. Finally make sure that the manufacturer has a local legal entity in Australia. Should you have a dispute in years to come, a company with no link and contact in Australia is hard to communicate with when it comes to consumer rights.

9. Choose a quality Inverter solution to go with quality panels: An inverter is the heart of your solar system. It will have a direct impact on the efficiency of conversion from solar power to usable electric power of your system. The more efficient the inverter solution, the better the energy conversion process will be. The bigger and more established the manufacturer, the more likely warranty claims or required repairs will be dealt with smoothly.

10. Quotes & Buying: Do not get pressured by sales persons to sign a deal then and there. Use reputable and established local businesses to install your solar system.